

Wide Span Storage Racks Assembly Guide

SMS-08-V39-HBR

General Instructions

1. Check material received against the packing list. Check the number of packages received and then check the contents of each package.
2. Check the material received for damage. If damage has occurred, secure a “damage notation” from the carrier
3. Identify each part as it is unpacked and put like parts together as close as possible to the working area where they are to be assembled.
4. Be careful to use the correct hardware as specified in the assembly instructions.

CAUTION

In the interest of safety, all shelving/rack must be securely anchored to the floor and/or wall. For safety, handle all components carefully and wear work gloves when assembling. Install all units plumb and tighten all hardware securely. Retain instructions for future reference.



STARTER UNIT

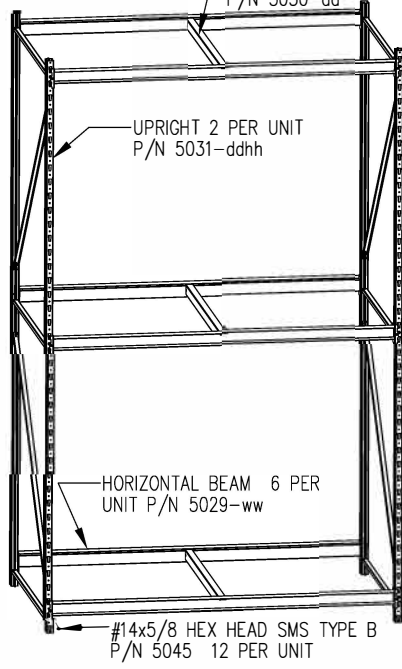

ADDER UNIT

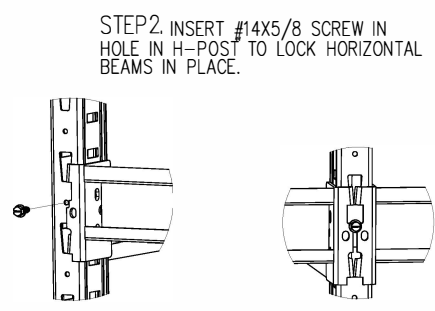
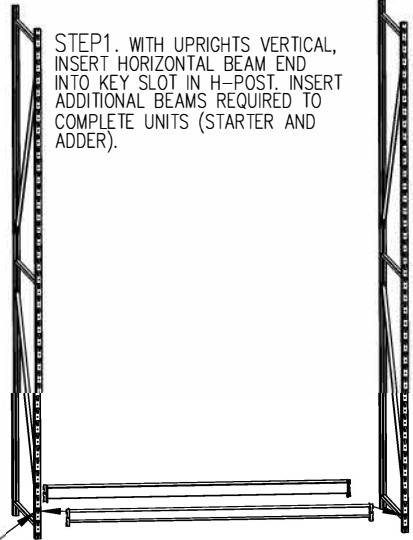
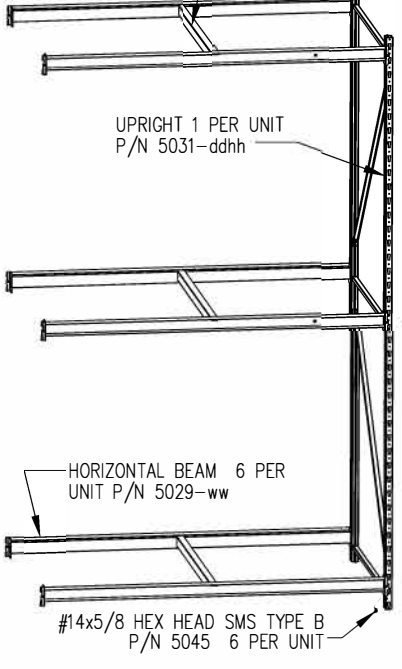

ECO		REV		REVISIONS		
DESCRIPTION	DATE	BY				

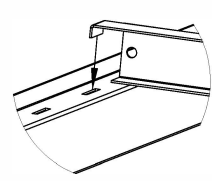

STEP3. HORIZON QUANTITI DECKING

T CENTER BRACE TAB IN SLOTS IN EAM. SEE BELOW FOR LOCATION AND SUPPORTS NEED FOR THE REQUIRED

ST INSERT DECKING AS REQUIRED.

FRONT TO BACK BRACE LOCATIONS

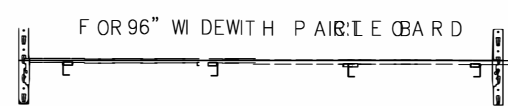
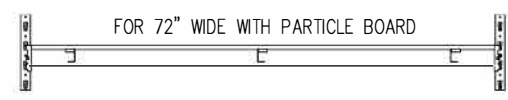
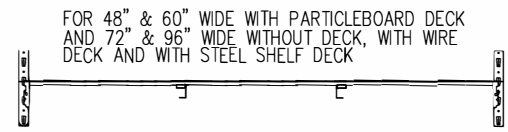

TOLERANCES UNLESS OTHERWISE SPECIFIED

INCHES	XX ± .010
	XXX ± .005
FRACTIONAL	X/X ± 1/64
ANGULAR	∠ ± 1/2°

UNLESS OTHERWISE SPECIFIED ALL DIMENSIONS ARE IN INCHES. METRIC DIMENSIONS WILL BE WITHIN [XX]

THIS DRAWING AND THE INFORMATION ON IT IS THE CONFIDENTIAL PROPERTY OF HALLOWELL AND SHALL NOT BE COPIED OR DISCLOSED TO OTHERS WITHOUT WRITTEN PERMISSION. ONLY HALLOWELL RESERVES THE RIGHT TO ALTER ANY DESIGN. ANY UNAUTHORIZED MODIFICATIONS RELEASES HALLOWELL FROM ALL LIABILITIES.



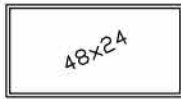

48x24

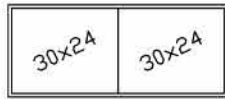

60x24

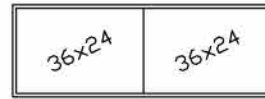

72x24



96x24

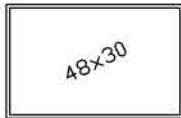

48x30

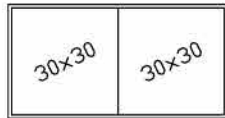

60x30

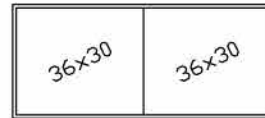

72x30

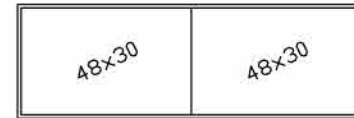

96x30

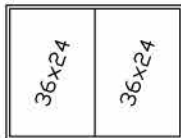

48x36

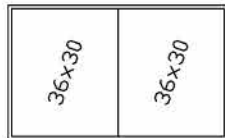

60x36



72x36

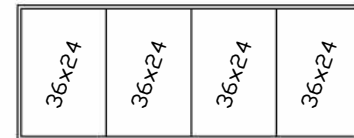

96x36



48x42

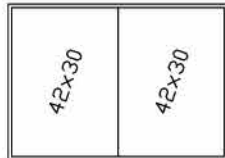

60x42

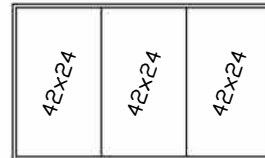

72x42



96x42

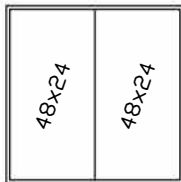

48x48

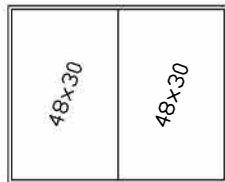

60x48

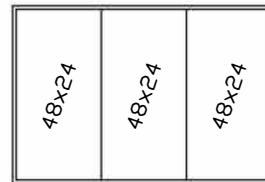

72x48



96x48

BULK RACK STEEL SHELF DECK PLACEMENT CHART

