

- No Kiosk Unit, (6x3)
- 18 Openings

Project Data

130332-1 Number

Rental Lockers Name

Southwest Solutions Company
Group

Dallas, TX Location

11/11/24 Date

Bhoward Planner

HT Sales

Copyright 2024 **Southwest Solutions Group**. This material is proprietary and confidential and the disclosure, reproduction (by photocopy, film, blueprint or otherwise) or incorporation into any information retrieval system without first receiving written approval from **Southwest Solutions Group** is expressly prohibited by law.

Revision schedule

RN Description

Sheet Info

6x3

Sheet Number

1.0

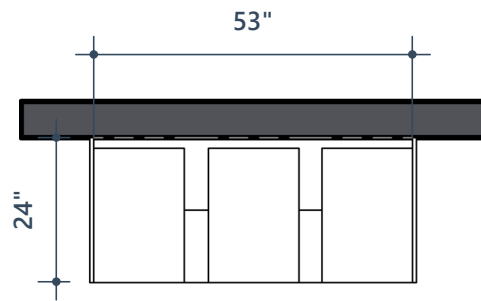

1 6x3
3/8" = 1'-0"

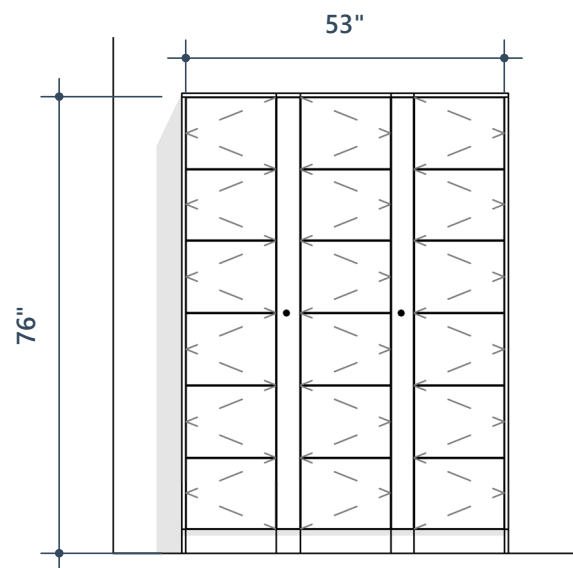

2 6x3
3/8" = 1'-0"

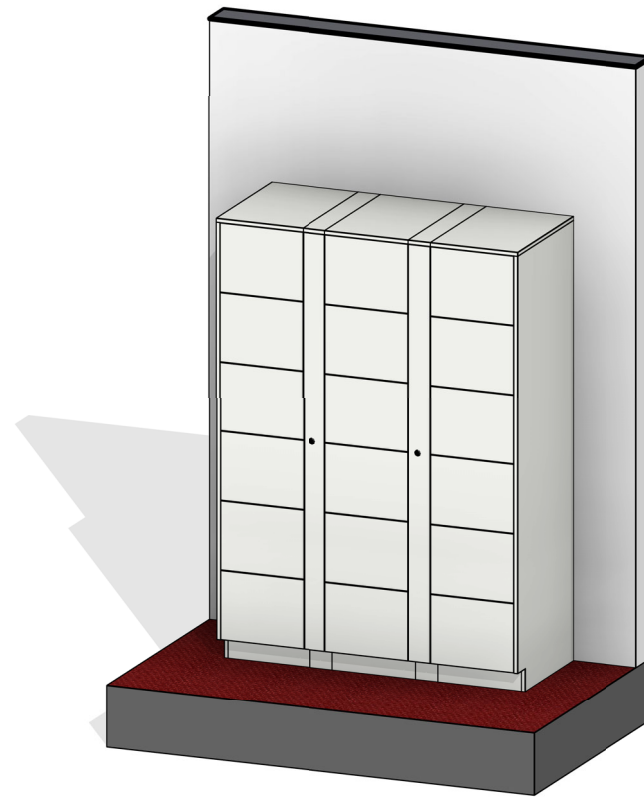

3 6x3 - Interior

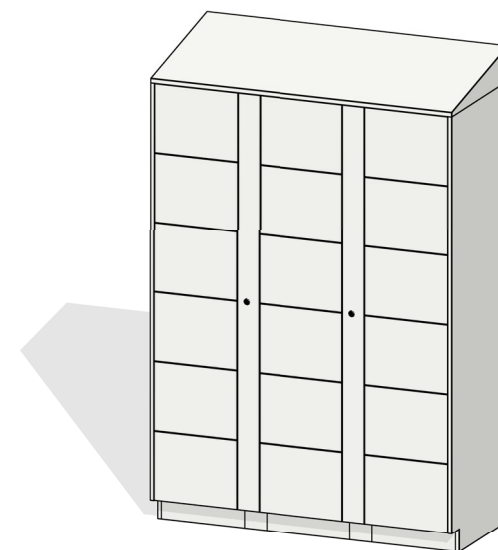

5 6x3



4 6x3 - Exterior

- No Kiosk Unit, (6x4)
- 24 Openings

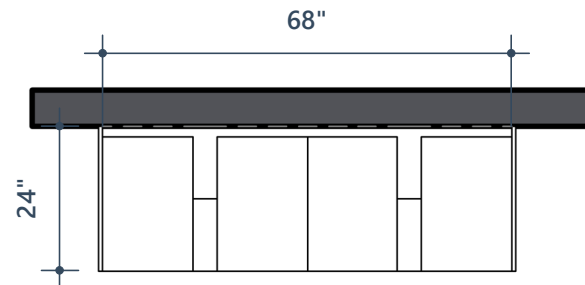

1 6x4
3/8" = 1'-0"

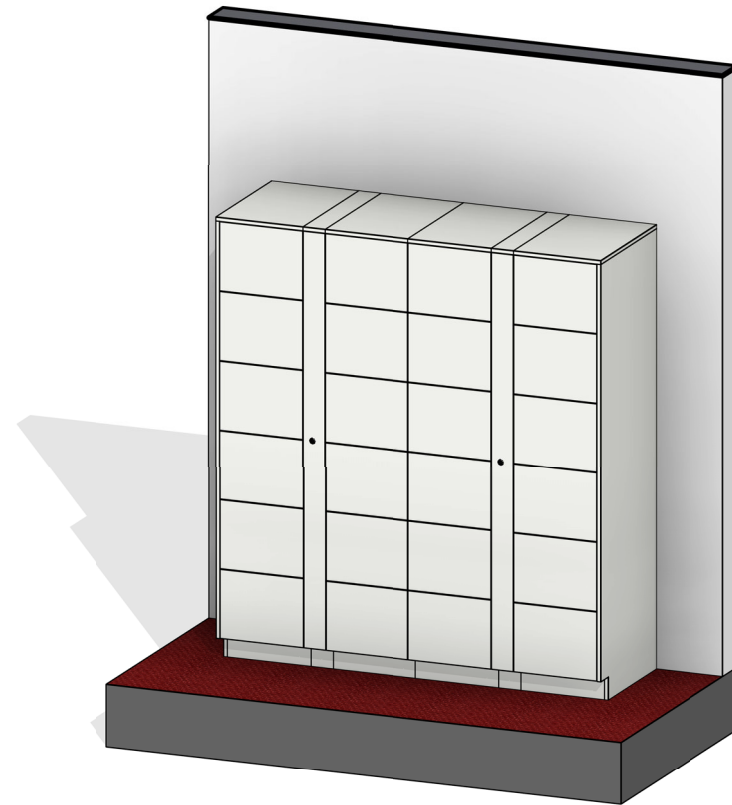

3 6x4 - Interior



4 6x4 - Exterior

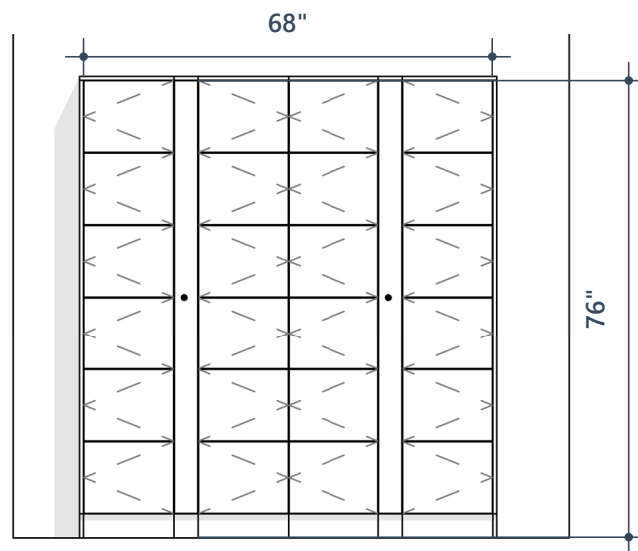

2 6x4
3/8" = 1'-0"

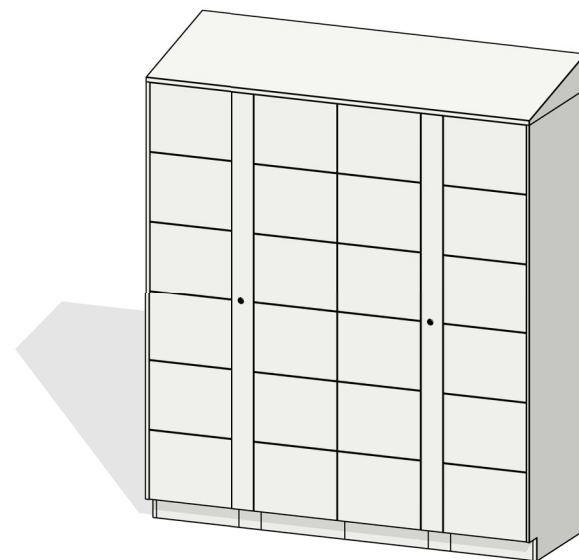

5 6x4

Project Data

130332-1 Number

Rental Lockers Name

Southwest Solutions Company
Group

Dallas, TX Location

11/11/24 Date

Bhoward Planner

HT Sales

Copyright 2024 Southwest Solutions Group. This material is proprietary and confidential and the disclosure, reproduction (by photocopy, film, blueprint or otherwise) or incorporation into any information retrieval system without first receiving written approval from Southwest Solutions Group is expressly prohibited by law.

Revision schedule

RN Description

Sheet Info

6x4

Sheet Number

1.1

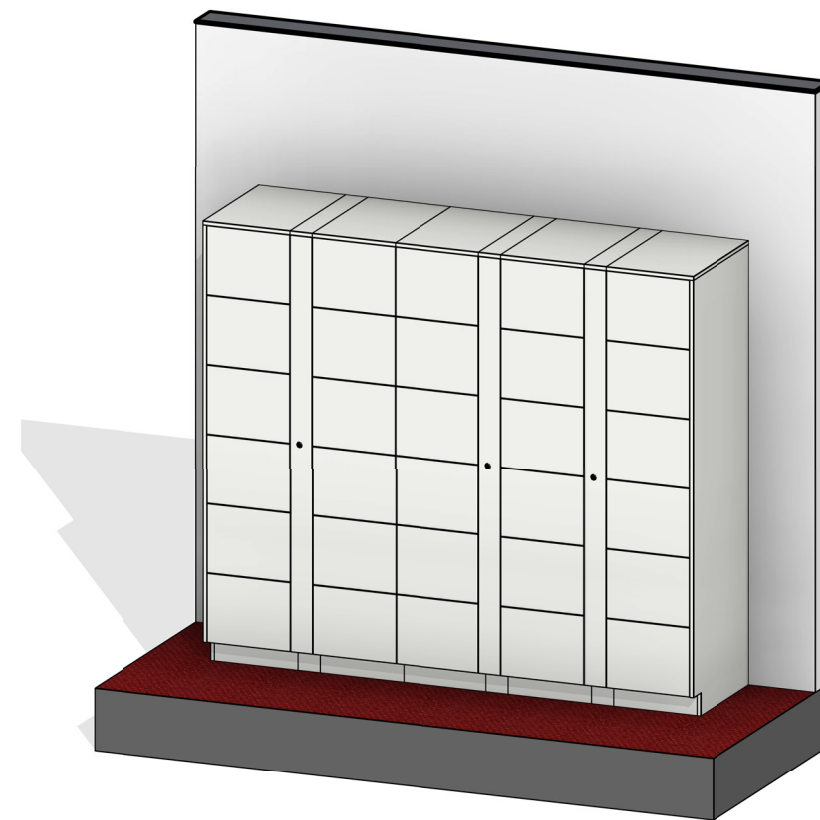
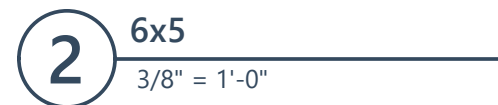
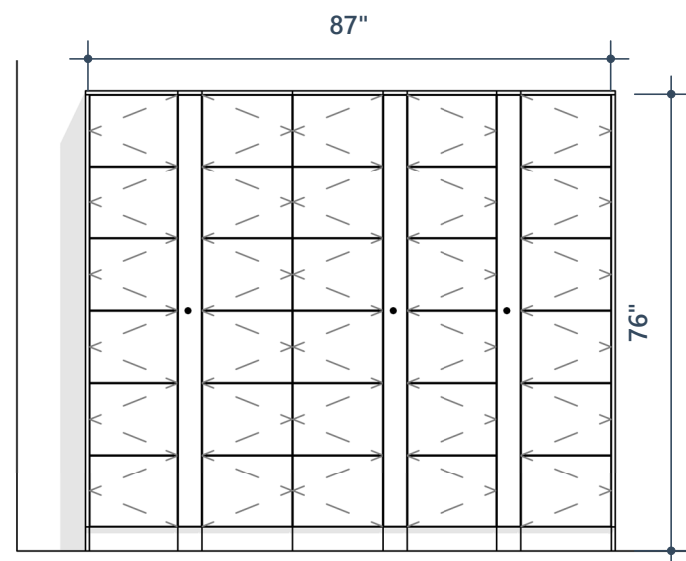
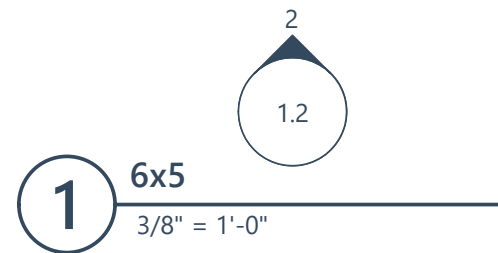
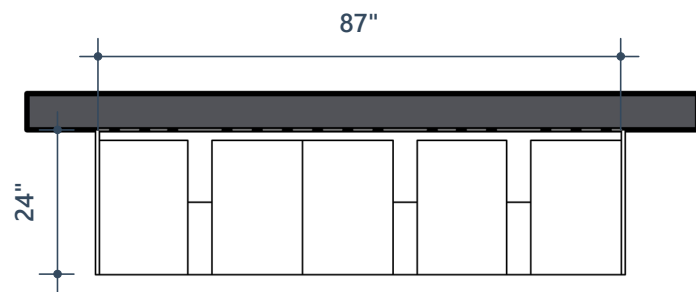

3 6x5 - Interior

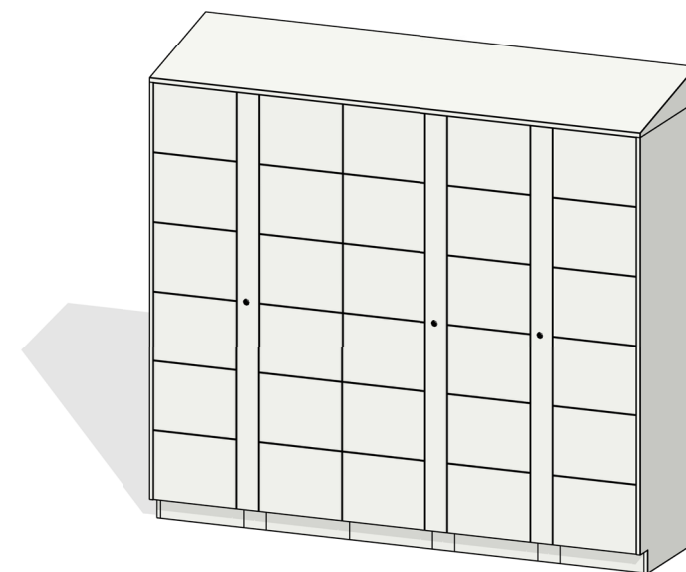

5 6x5

- No Kiosk Unit, (6x5)
- 30 Openings

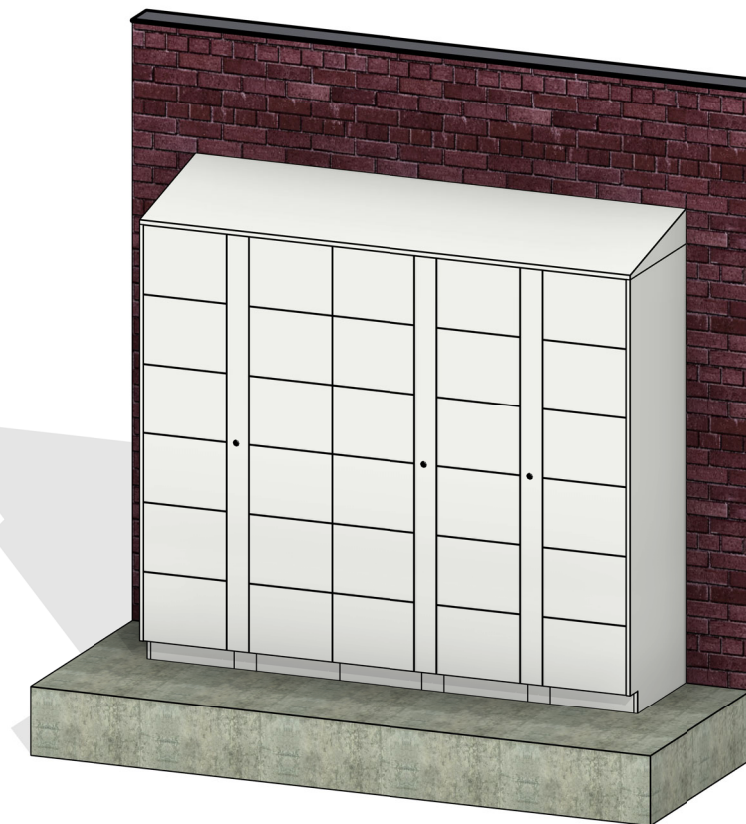

4 6x5 - Exterior

Copyright 2024 Southwest Solutions Group. This material is proprietary and confidential and the disclosure, reproduction (by photocopy, film, blueprint or otherwise) or incorporation into any information retrieval system without first receiving written approval from Southwest Solutions Group is expressly prohibited by law.

- No Kiosk Unit, (6x6)
- 36 Openings

Project Data

130332-1 Number

Rental Lockers Name

Southwest Solutions Company
Group

Dallas, TX Location

11/11/24 Date

Bhoward Planner

HT Sales

Copyright 2024 Southwest Solutions Group. This material is proprietary and confidential and the disclosure, reproduction (by photocopy, film, blueprint or otherwise) or incorporation into any information retrieval system without first receiving written approval from Southwest Solutions Group is expressly prohibited by law.

Revision schedule

RN Description

Sheet Info

6x6

Sheet Number

1.3

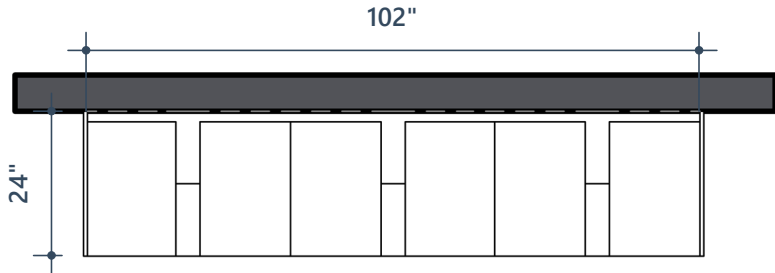

1 6x6
3/8" = 1'-0"

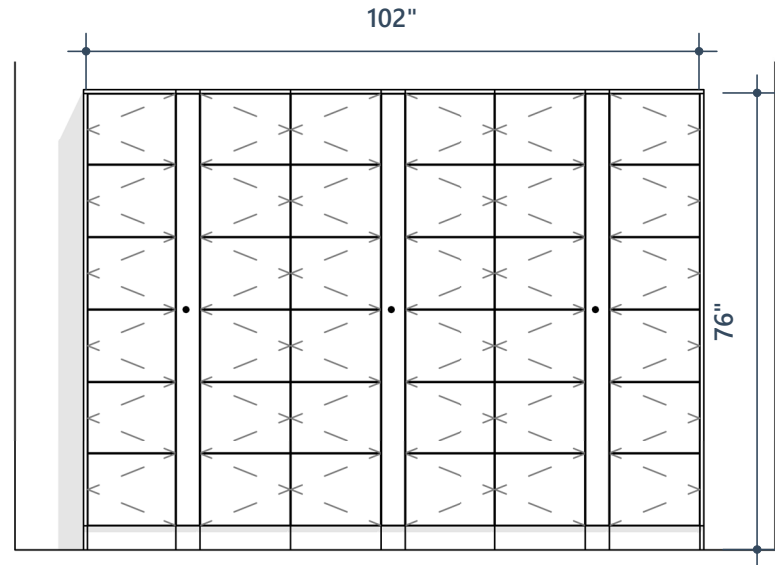

2 6x6
3/8" = 1'-0"

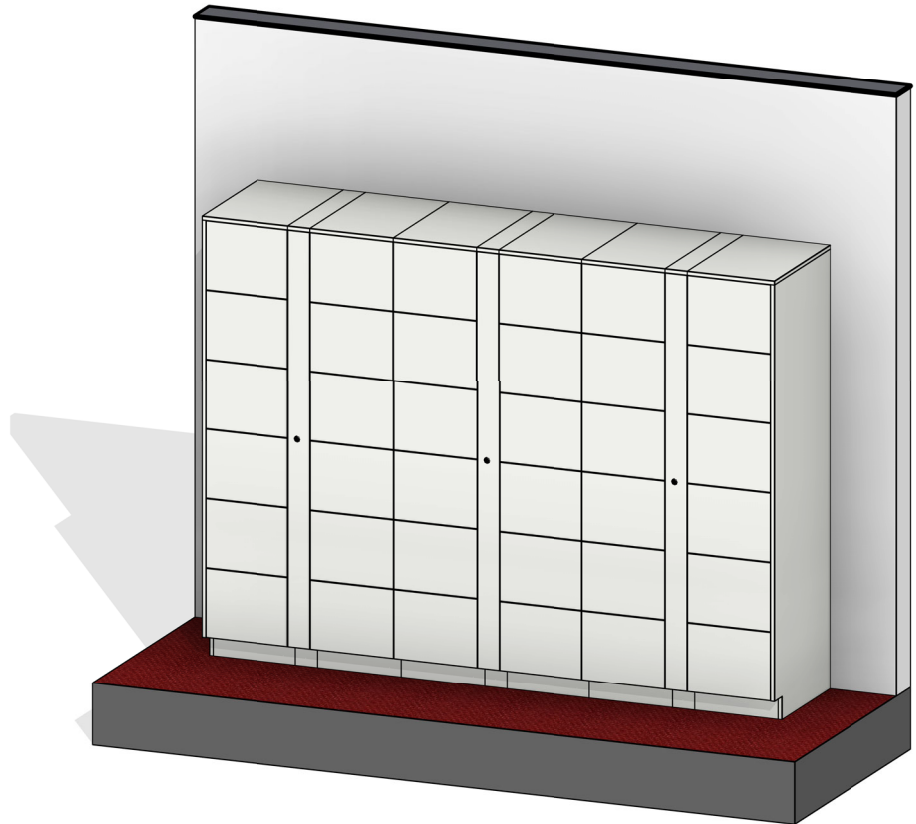

3 6x6 - Interior

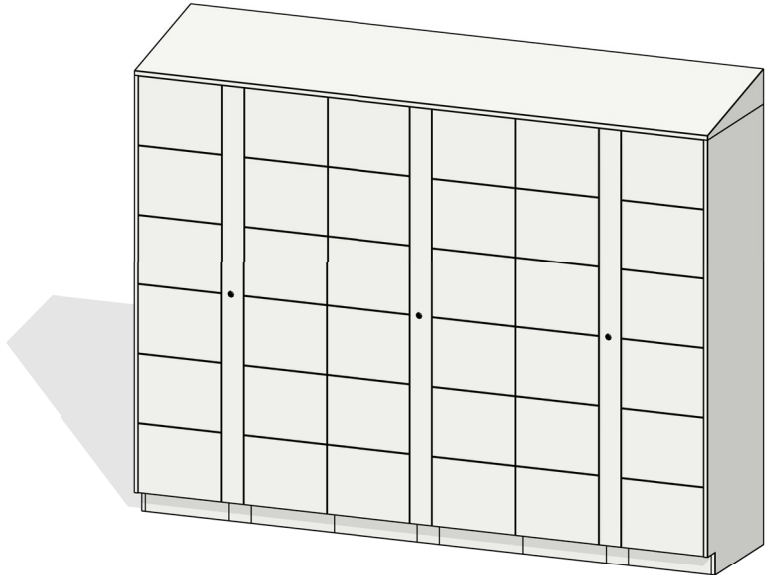

5 6x6

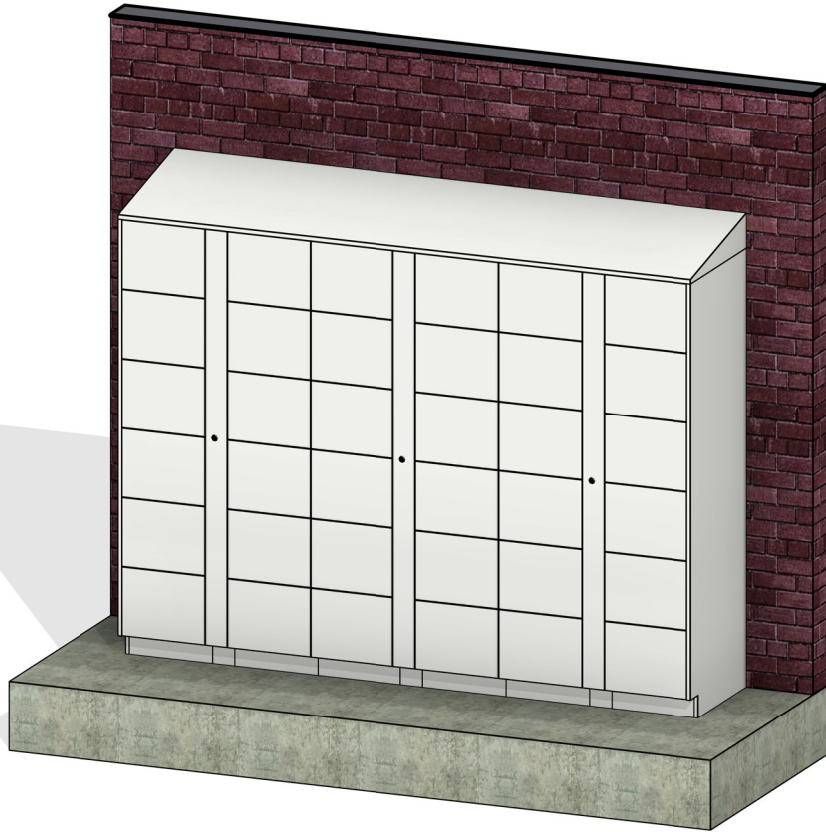

4 6x6 - Exterior

- No Kiosk Unit, (6x7)
- 42 Openings

Project Data

130332-1 Number

Rental Lockers Name

Southwest Solutions Company
Group

Dallas, TX Location

11/11/24 Date

Bhoward Planner

HT Sales

Copyright 2024 **Southwest Solutions Group**. This material is proprietary and confidential and the disclosure, reproduction (by photocopy, film, blueprint or otherwise) or incorporation into any information retrieval system without first receiving written approval from **Southwest Solutions Group** is expressly prohibited by law.

Revision schedule

RN Description

Sheet Info

6x7

Sheet Number

1.4

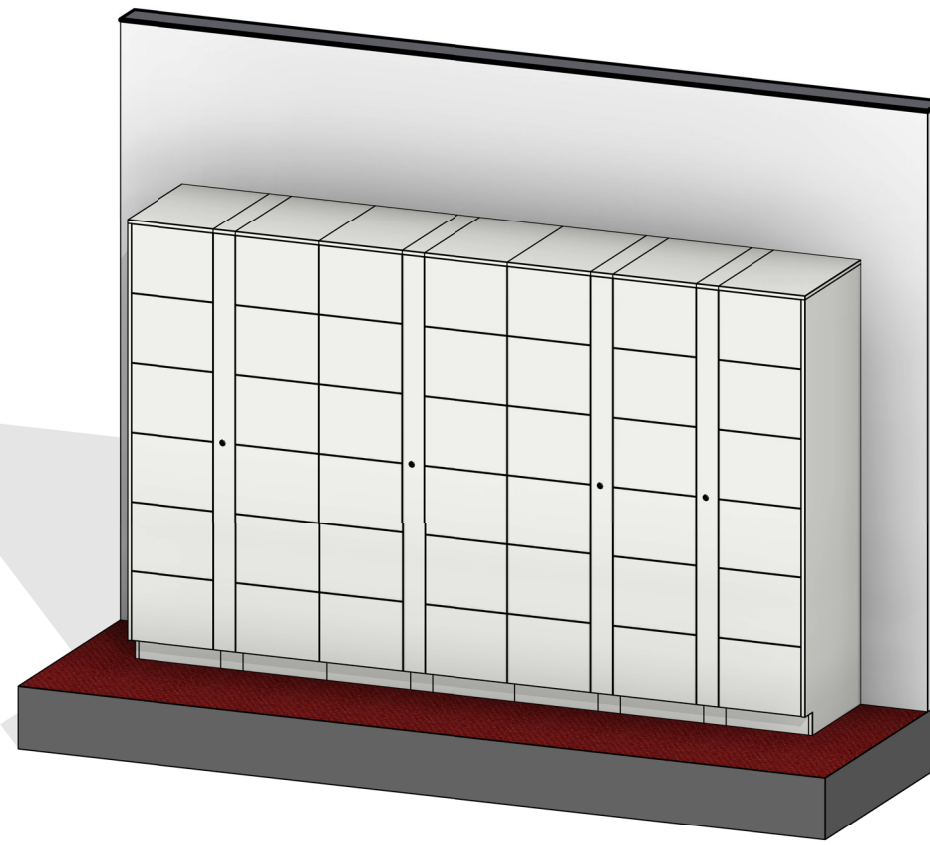

3 6x7 - Interior

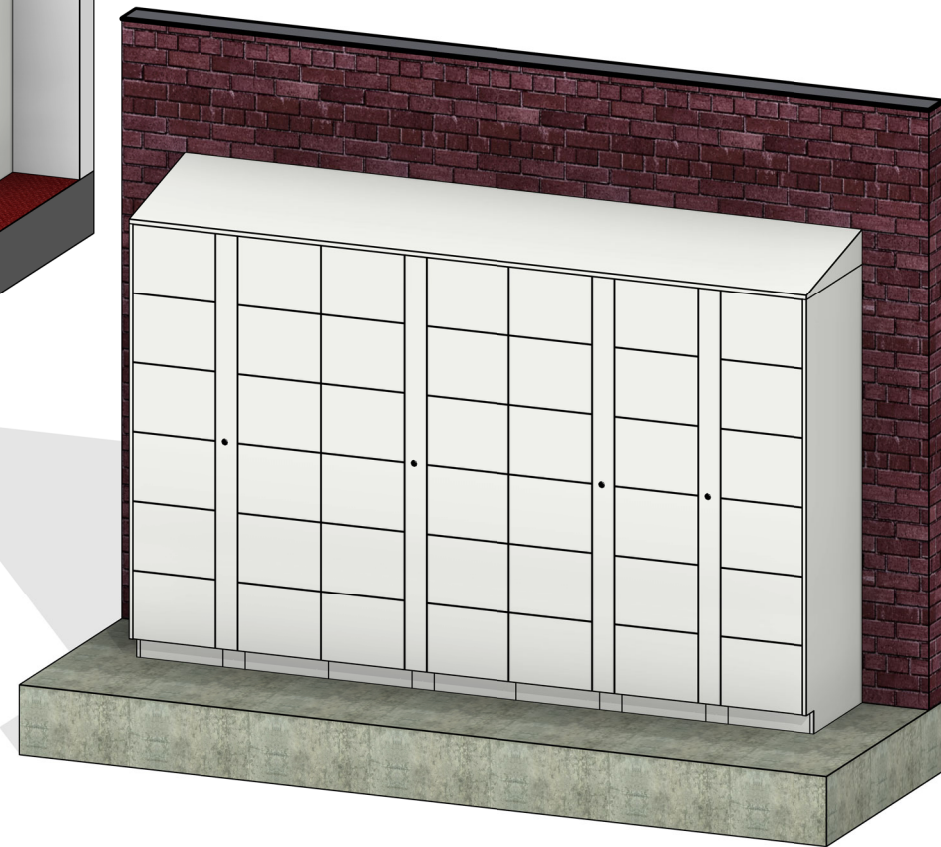

4 6x7 - Exterior

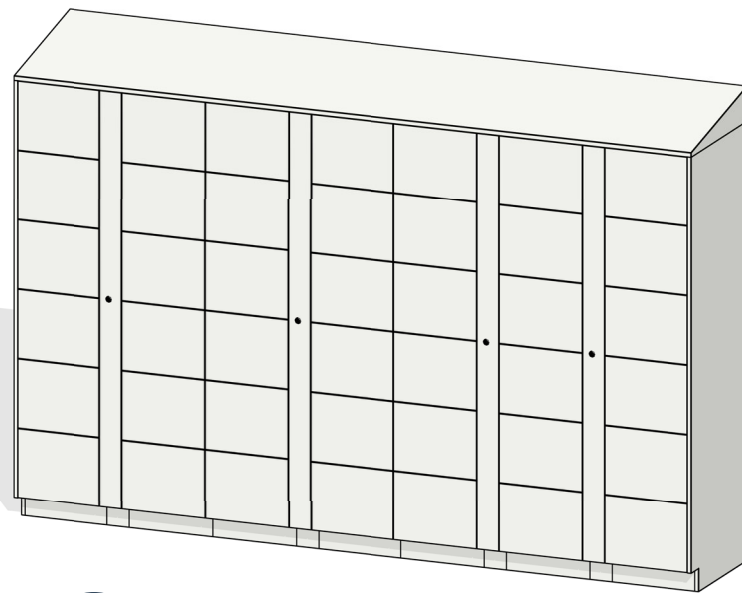

5 6x7

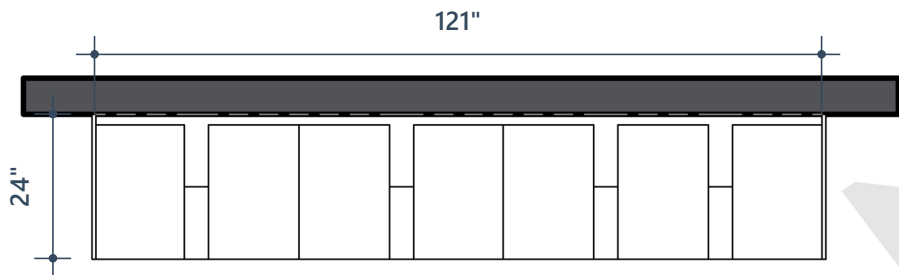

1 6x7
3/8" = 1'-0"

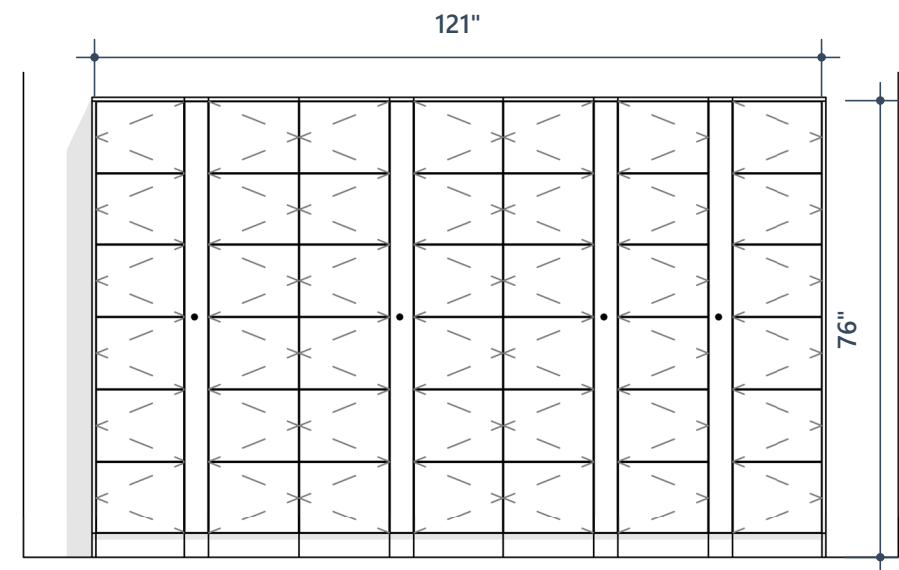

2 6x7
3/8" = 1'-0"

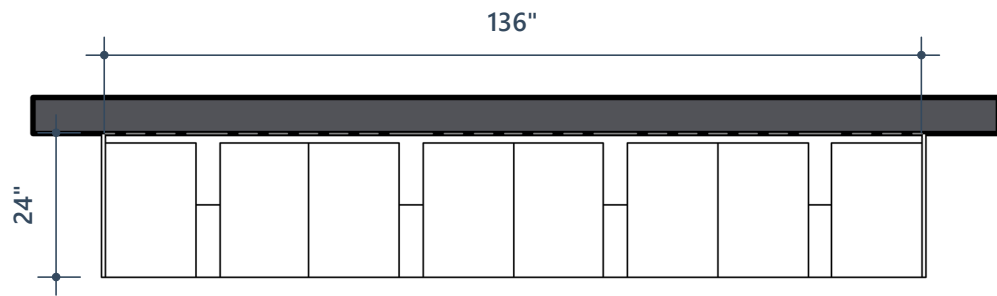

1 6x8
3/8" = 1'-0"
136"

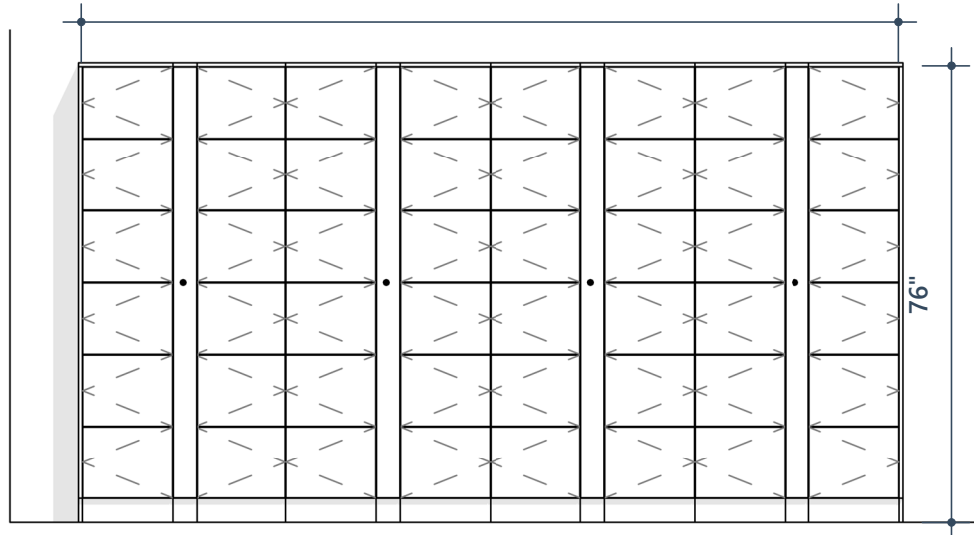

2 6x8
3/8" = 1'-0"

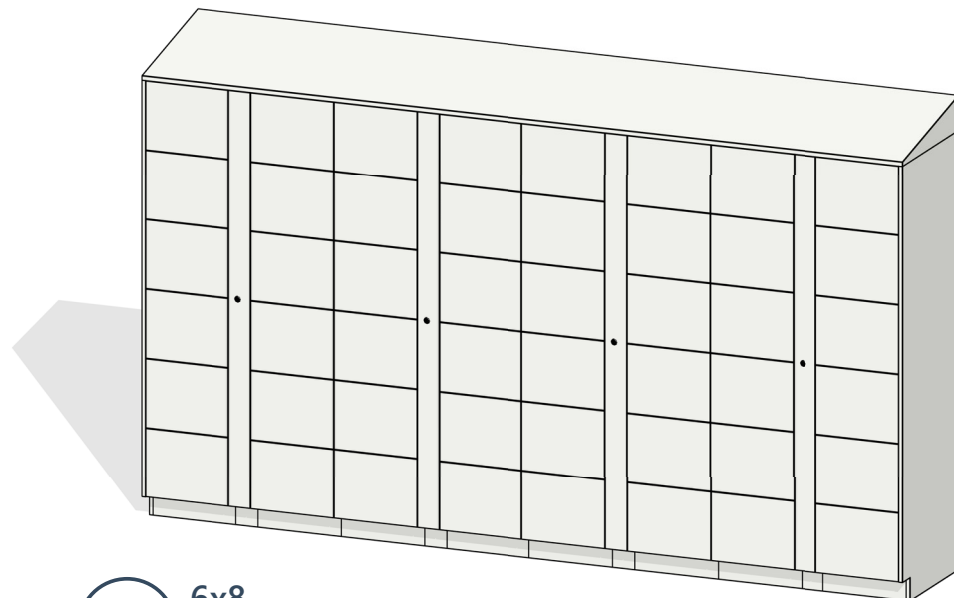

5 6x8

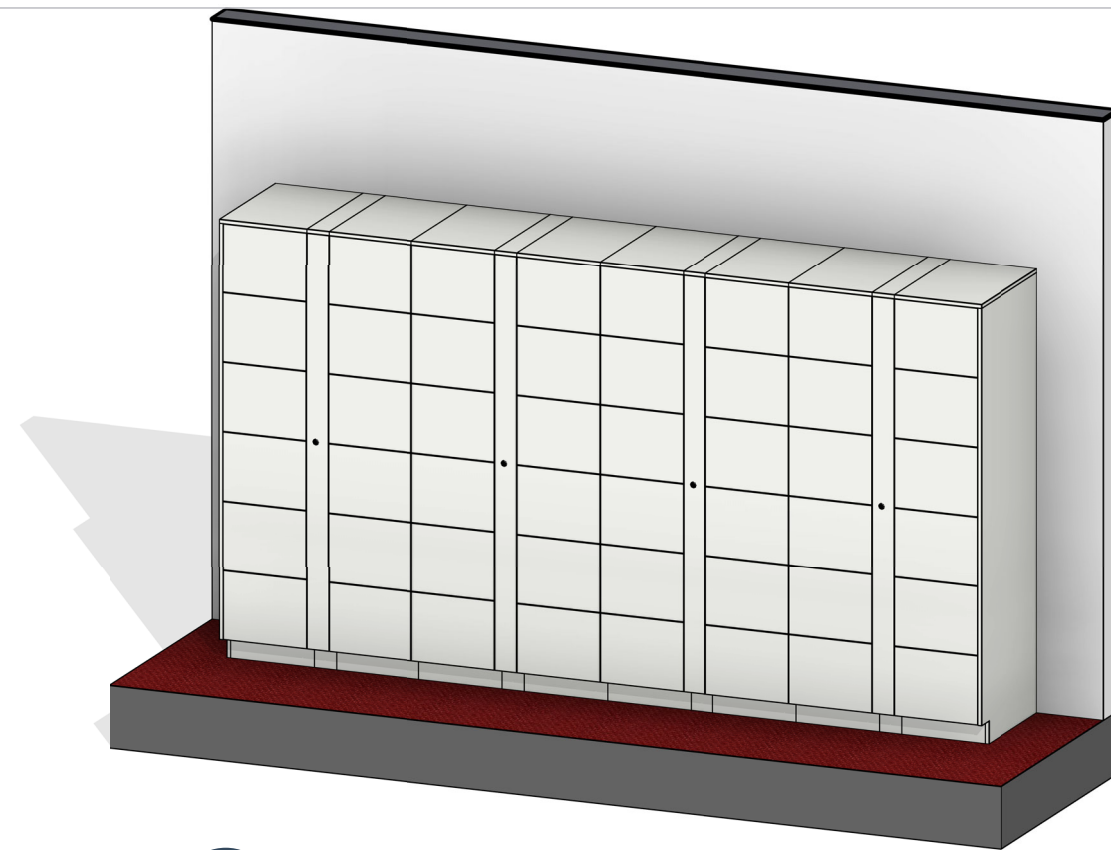

3 6x8 - Interior

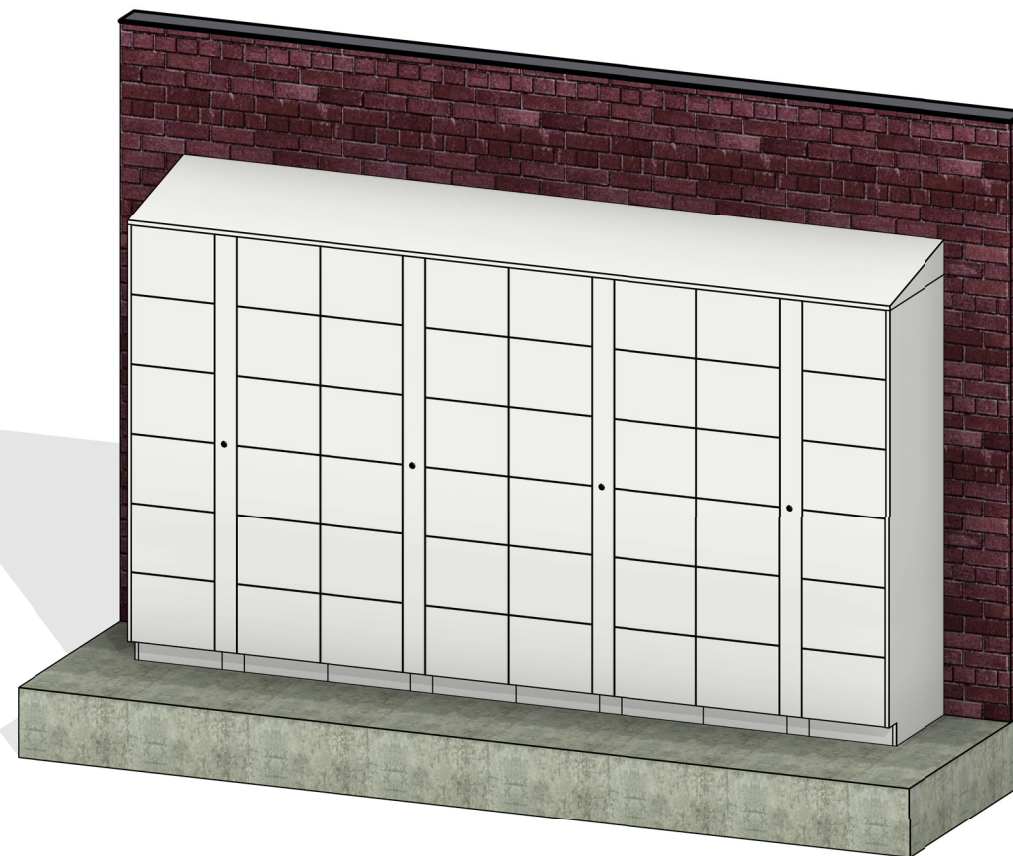

4 6x8 - Exterior

- No Kiosk Unit, (6x8)
- 48 Openings

Project Data

130332-1 Number

Rental Lockers Name

Southwest Solutions Company
Group

Dallas, TX Location

11/11/24 Date

Bhoward Planner

HT Sales

Copyright 2024 **Southwest Solutions Group**. This material is proprietary and confidential and the disclosure, reproduction (by photocopy, film, blueprint or otherwise) or incorporation into any information retrieval system without first receiving written approval from **Southwest Solutions Group** is expressly prohibited by law.

Revision schedule

RN Description

Sheet Info

6x8

Sheet Number

1.5