

Unit Drawing + Color

SouthWest Solutions Group

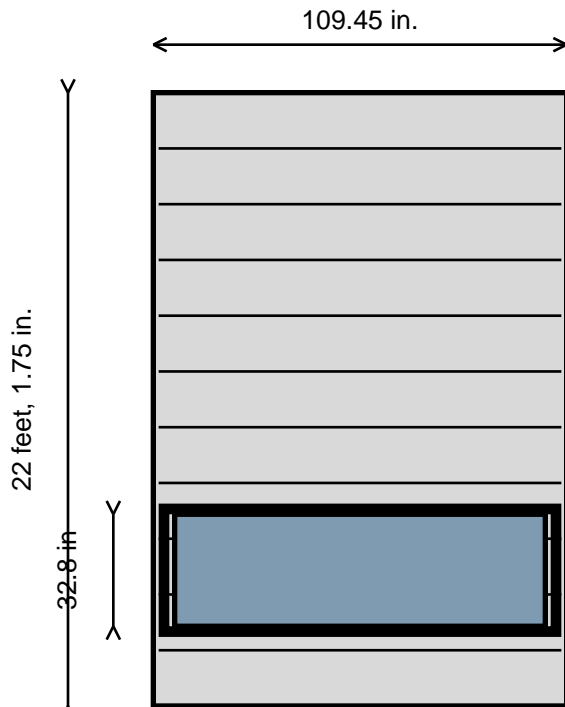

Front View

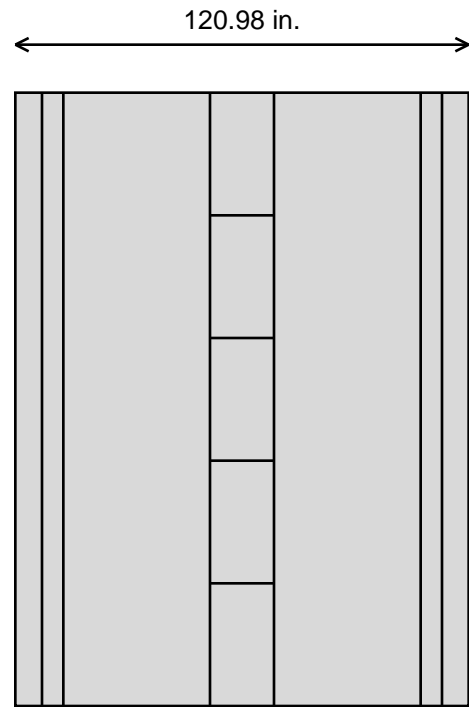

Side View

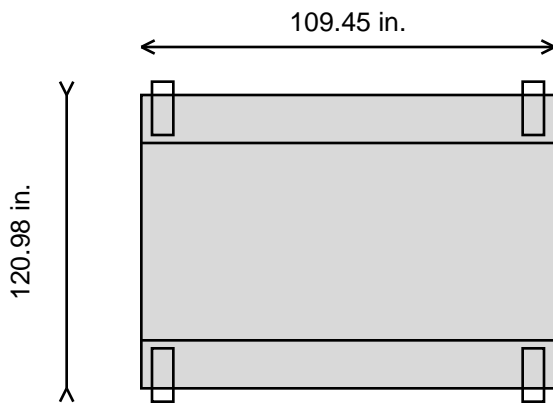

Top View

SouthWest Solutions Group

Date	4/5/2026
Customer	VLM Option #4 - 96 x 34 Strong w Larger Lip
Model	SHUTTLE-01-500-2450x864x6750

Drawing Not to Scale

Color Illustration is based on the current unit design

- (A) Panels and Load Profiles : RAL 7035 Light Grey
- (B) Shutter Door and Cover under Access Opening : RAL 230/60/15 Silver Fir Blue
- (C) Shelf Rail Panels : RAL 7035 Light Grey
- (D) Access Opening (Inside cover and floor) : RAL 7035 Light Grey
- Cover above access opening : Always RAL 9016 Traffic White
- Side Covers of access opening (light barrier holder) : Always RAL 7016 Anthracite Grey